

Capacity Information				
Capacity	17,139 Watt		Heat Transfer Surface	63,39 m ²
Average Room Temperature	0 °C		Tube Volume	22,33 dm ³ .
Evaporation Temperature	-8 °C		Fin Spacing	8 mm
ΔT	8 K		Test Pressure / Max. Operating Pressure	35 bar
Refrigerant	R404A		Energy Efficiency Class	D
Altitude	0 m		Air Throw Distance	0 m

Fan Specifications				
Air Flow	12.270 m ³ /h		Fan Protection	IP 54
Number of Fans / Fan Diameter / Fan Cycle	2/500mm/1400rpm		Operating Temperature Range	-25/75
Total Fan Power / Current	1.6 kW / 6,6 A		Sound Power Level (LWA)	66 dBA
Fan Voltage / Fan Frequency / Fan Phase	230Volt/50Hz/1 Ph		Sound Pressure Level (LPA)	35dBA@3m
Fan Rankings	1x2			

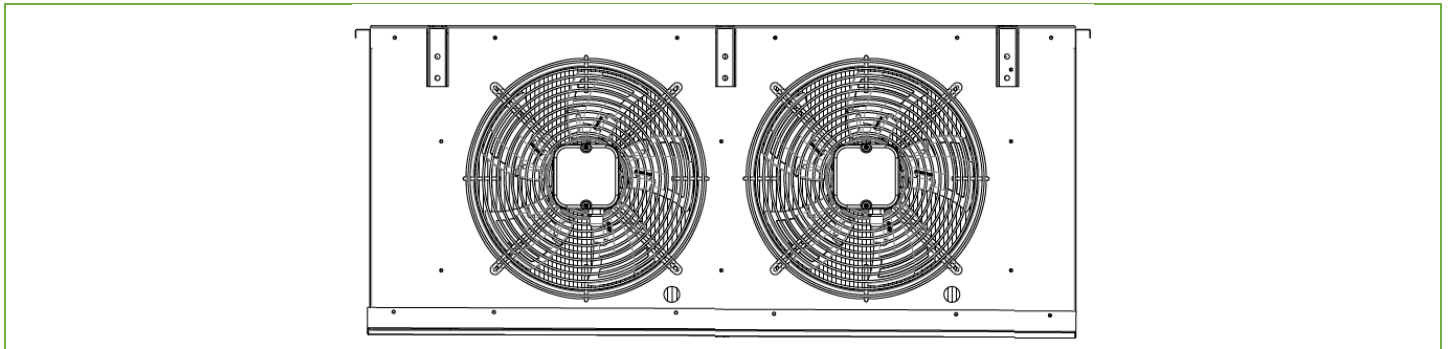

Dimensions							
Width	692 mm	Inlet Line	5/8"	Length	1.680 mm	Outlet Line	1.3/8"
Collector Qty	1	Weight	109 kg	Height	725 mm		

Notes.

- Capacity correction calculation for altitude is according to related Eurovent Standard.
- Sound pressure calculation standard: EN13487
- Energy Efficiency Class calculation standards: EN328 and Related Eurovent Standard. Standard Conditions: SC2,R404A
- All of the technical information is subject to change without notice.
- All of the performance and technical data according to default configuration.